

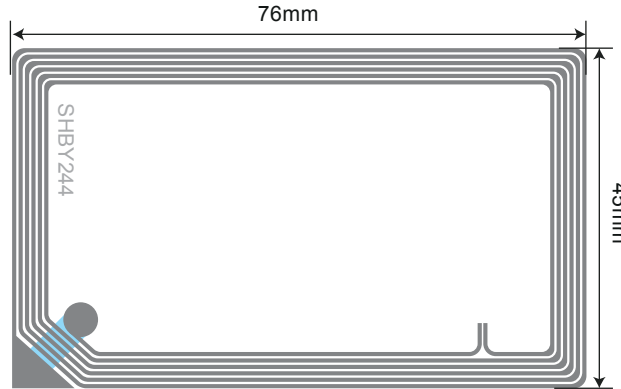

Antenna 1020244 76x45mm

Example of Dry Inlay/Product



Antenna Design

Top: Aluminum 30 μm
Substrate: PET 38 μm
Bottom: Aluminum 10 μm

Antenna No.	Pitch	Chip
1020244	CD48 / MD80 (5 rolls)	Mifare UL

Unwinding Direction

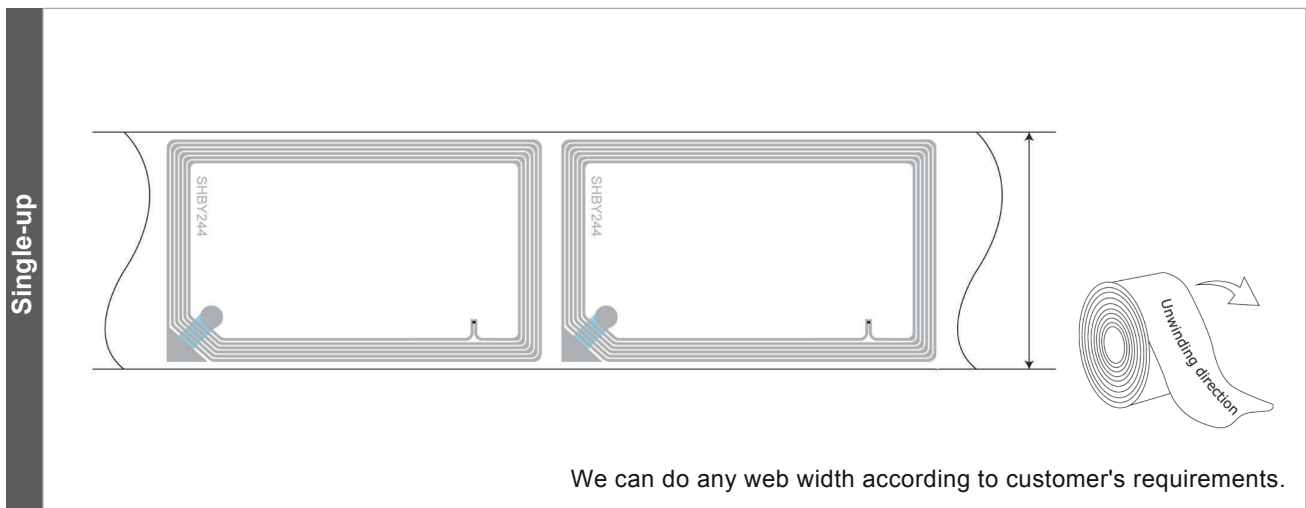

Multiple-up

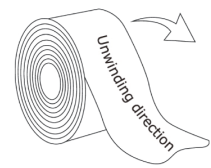
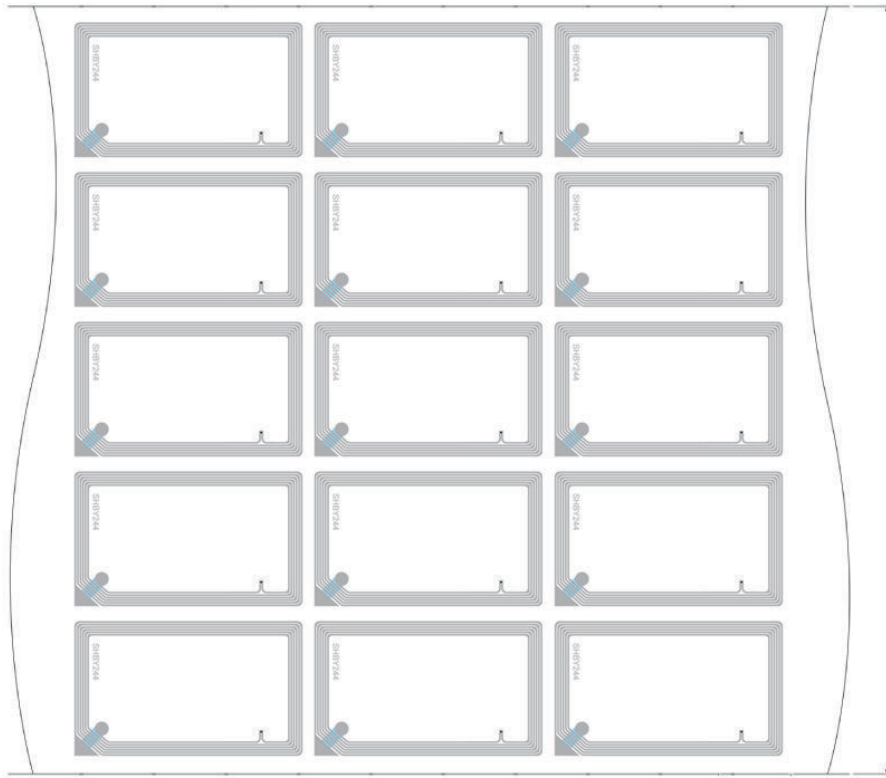

We can do any web width according to customer's requirements.