

Antenna 1020657 43x28mm

Example of Label/Product

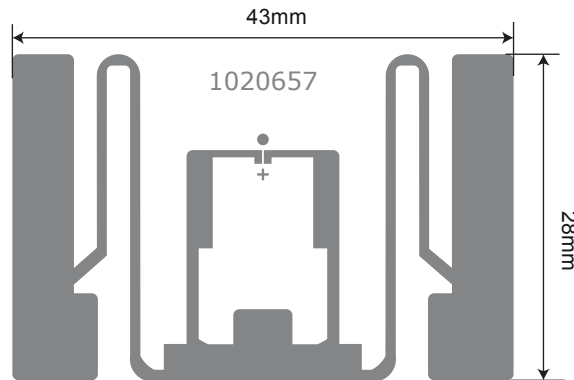

Antenna Design

Top: Aluminum/10 μ m
Substrate: PET/50 μ m

Die-cut Size	Antenna Position (on the web)	Chip	Form Factor
47x32mm	WEL	NXP U CODE 7/NXP U CODE 8	Paper / PET / PP / Nylon / Satin / Hangtag

We can make more label size according to customer's requirements.

